

SCEPTER

- 50" Gas Fireplace
- Mosaic Masonry™ Technology
- Full Masonry Design
- Full Length Nailing Flanges
- 8" Desa Double Wall or 8" "B" Type Venting

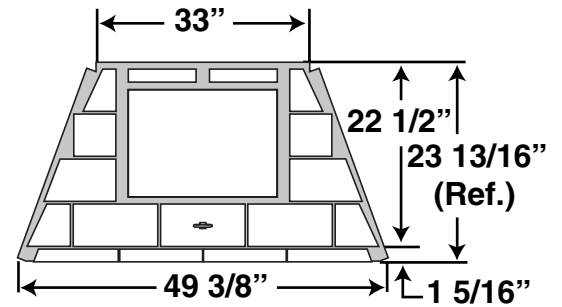

Hearth Dimensions

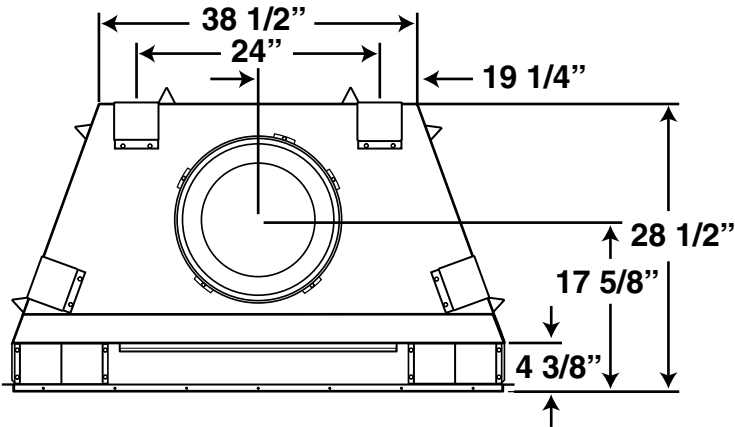
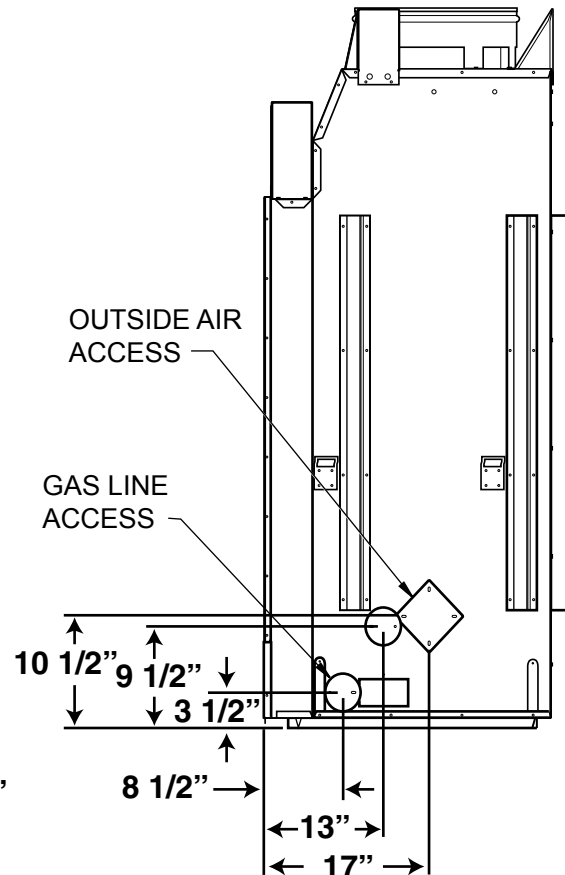
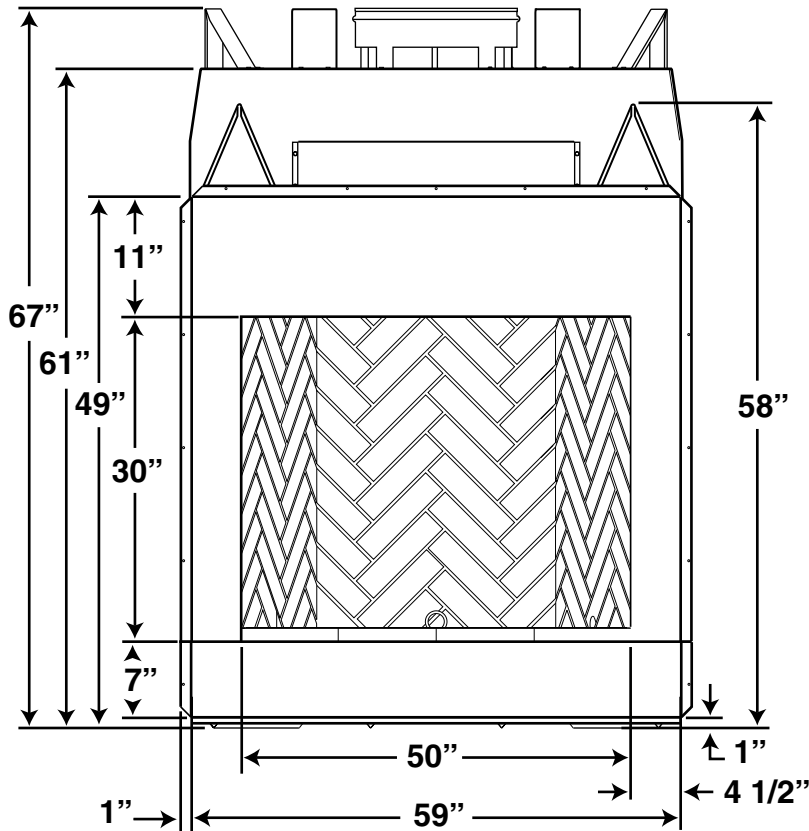

SCEPTER

50" Gas Fireplace

Framing Dimensions

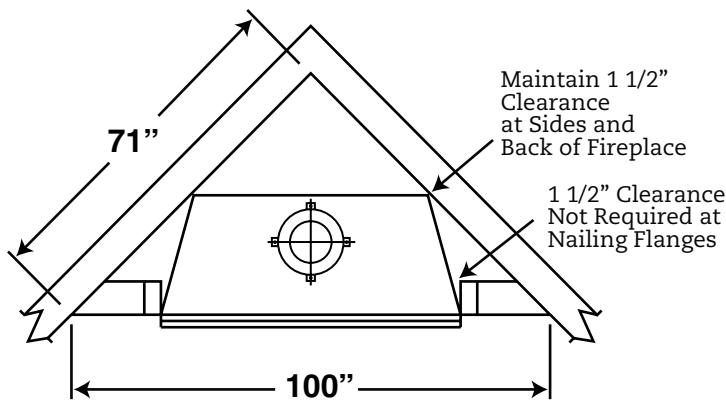
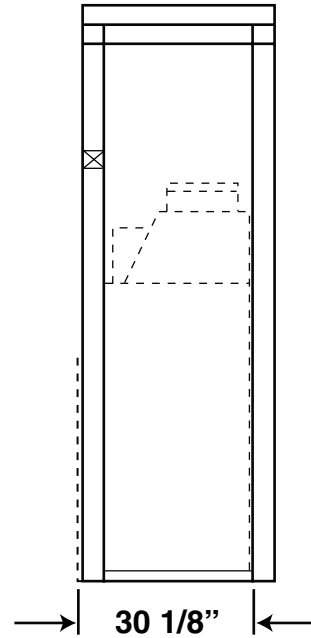
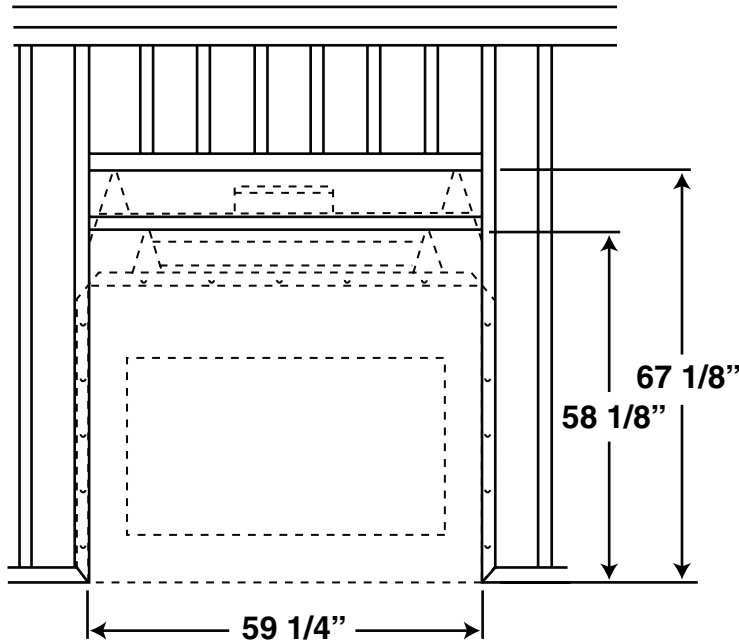

Ceiling/ Roof Opening Chart			
Pitch	Slope	Opening "A" Max.	Used Flashing Model No.
Flat	0°	15"	V6F-8DM
0-6/12	26.6°	16 1/8"	V6F-8DM
6/12- 12/12	45.0°	20 3/8"	V12F-8DM

Minimum Measurements

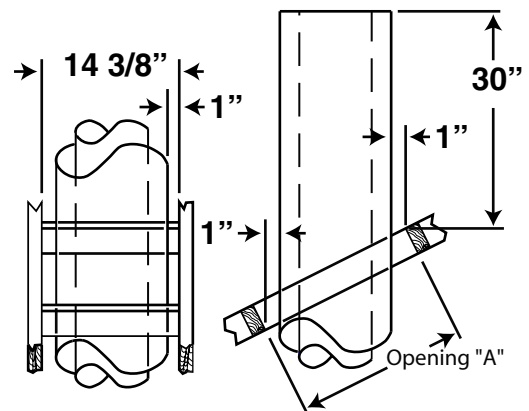

NOTE:

Built-in Features Such as Mantels, Bookshelves, etc. Made of Combustible Materials Must Maintain Minimum Clearances from the Fireplace. See Installation Instructions for Complete Information.

“Product design, features and specifications are subject to change at any time. Refer to current product instructions prior to installation.”

